













# UTILK Cuțite cu lamă

TRACON					
UTILK01		168 × 35 × 18 mm	l=110; d=18; x=0,7 (×4)	Zn + TPR	250 g
UTILK02		178 × 33 × 19 mm	l=110; d=18; x=0,7 (×1)	Zn + TPR	250 g
UTILK03		155 × 33 × 19 mm	l=110; d=18; x=0,7 (×1)	ABS + TPR	125 g
UTILK04		175 × 41 × 27 mm	l = 62; d=19; x=0,6 (×1)	Al + TPR	194 g
UTILK05		149 × 19 × 17 mm	l=90; d=12.5; x=0,2mm (×1)	ABS	59 g
UTILK06		140 × 23 × 18 mm	l=90; d=12.5; x=0,2mm (×1)	Al	80 g
UTILK07		145 × 22 × 18 mm	l=82; d=9; x=0,6mm (×1)	TPR	54 g
UTILK08		145 × 21 × 17 mm	l=82; d=9; x=0,6mm (×1)	ABS	50 g

**UTILK01**  
Mâner din zinc cu inserție din cauciuc

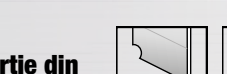
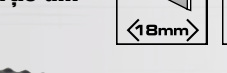

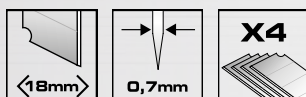
**UTILK05**  
Lamă flexibilă SK4, fixare cu arc, mâner ABS

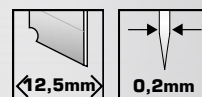

**UTILK02**  
Mâner aliaj zinc cu inserție din cauciuc

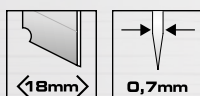

**UTILK06**  
Lamă flexibilă SK4, cu montare fixă, aliaj de aluminiu

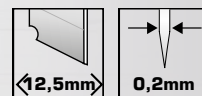

**UTILK03**  
Mâner din ABS cu inserție din cauciuc

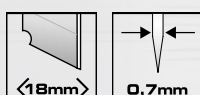

**UTILK07**  
Lamă îngustă SK4, montare cu arc, agățătoare, mâner din cauciuc TPR

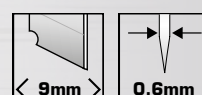

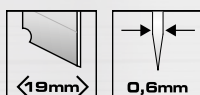

**UTILK04**  
Cuțit cu lame trapez mâner din Al cu inserție din cauciuc

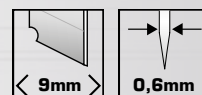

**UTILK08**  
Lamă îngustă SK4, montare cu arc, mâner ABS



# BD Lame cutter

TRACON		
<b>BD02</b>	l=90; d=12,5; x=0,2mm; (x30)	38 g
<b>BD05</b>	l=110; d=18; x=0,5mm; (x10)	105 g
<b>BD06</b>	l=110; d=18; x=0,6mm; (x10)	115 g
<b>BD07</b>	l=110; d=18; x=0,7mm; (x10)	125 g
<b>BDT06</b>	l=62; d=19; x=0,6mm; (x10)	92 g
<b>BD069</b>	l=82; d=9; x=0,6mm; (x10)	38 g

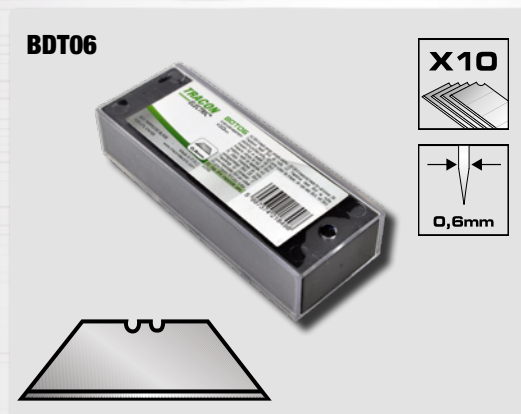
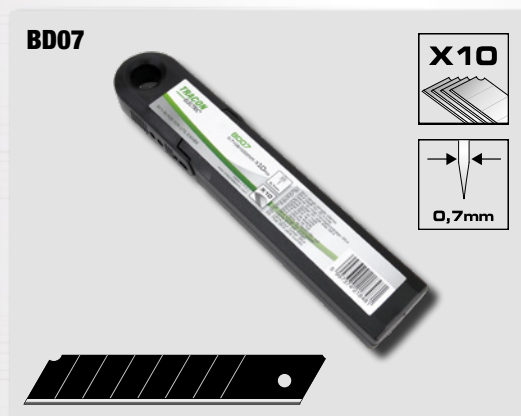
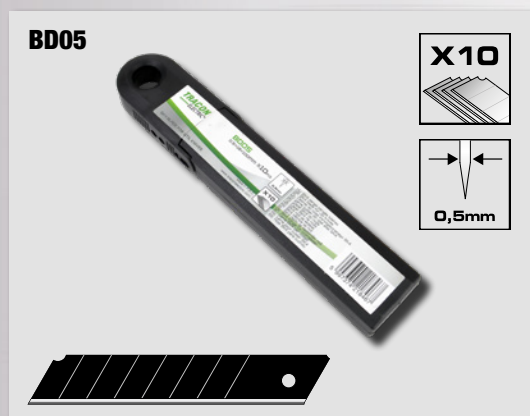

- Extrem de ascuțit • De 5 ori mai rezistentă decât lama convențională • Oțel inoxidabil
- Ascuțirea cu laser are ca rezultat o duritate mai mare cu câteva grade
  - Mai ales pentru sarcini dificile • Oțel de scule SK4